

VACUUM Handling Tools & Accessories

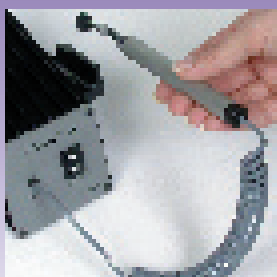

MICROTRONIC MICROELECTRONIC VERTRIEBS GMBH

Virtual Industries, Inc.

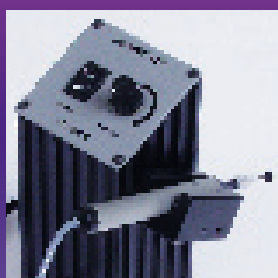
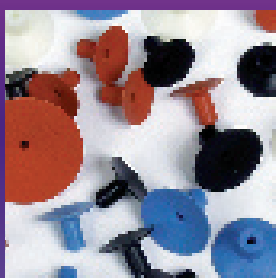
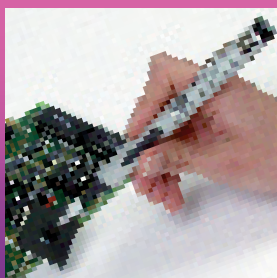





SELF CONTAINED MANUALLY OPERATED HANDLING TOOLS



PEN-VAC®

ESD-SAFE VACUUM HANDLING TOOLS

STATIC DISSIPATIVE NON-MARKING BUNA-N CUPS TEMPERATURE RANGE (-5°F + 250°F) (-20°C + 120°C)

PEN-VAC WITH 4 PROBES + CUPS Three bent probes with 1/8" (3.18mm), 1/4" (6.35mm), 3/8" (9.53mm), diameter vacuum cups, one straight probe with 1/4" (6.35mm) diameter vacuum cup.	1-4	5-24 PRICE EACH	25-UP
VI-V8901-A-B Standard PEN-VAC, static dissipative Buna-N cups	€ 70.00	-	-
VI-V8920E-A-B Junior PEN-VAC, static dissipative Buna-N cups	€ 70.00	-	-
			
PEN-VAC KIT WITH 6 PROBES + CUPS Two of each size cup on one bent and one straight probe. Cup sizes are 1/8" (3.18mm), 3/16" (4.76mm), 1/4" (6.35mm) diameter.	1-4	5-24 PRICE EACH	25-UP
VI-V8901-MPS-B Standard PEN-VAC, static dissipative Buna-N cups	€ 70.00	-	-
VI-V8920E-MPS-B Junior PEN-VAC, static dissipative Buna-N cups	€ 70.00	-	-
			
PEN-VAC KIT WITH 6 PROBES + CUPS Two of each size cup on one bent and one straight probe. Cup sizes are 1/8" (3.18mm), 1/4" (6.35mm), 3/8" (9.53mm) diameter.	1-4	5-24 PRICE EACH	25-UP
VI-V8901-LMS-B Standard PEN-VAC, static dissipative Buna-N cups	€ 70.00	-	-
VI-V8920E-LMS-B Junior PEN-VAC, static dissipative Buna-N cups	€ 70.00	-	-
			
PEN-VAC KIT WITH 6 PROBES + CUPS Two of each size cup on one bent and one straight probe. Cup sizes are 1/4" (6.35mm), 3/8" (9.53mm), 1/2" (12.7mm) diameter.	1-4	5-24 PRICE EACH	25-UP
VI-V8901-HLM-B Standard PEN-VAC, static dissipative Buna-N cups	€ 70.00	-	-
VI-V8920E-HLM-B Junior PEN-VAC, static dissipative Buna-N cups	€ 70.00	-	-
			
PEN-VAC KIT WITH 10 PROBES + CUPS Two of each size cup on one bent and one straight probe. Cup sizes are 1/8" (3.18mm), 3/16" (4.76mm), 1/4" (6.35mm), 3/8" (9.53mm), 1/2" (12.7mm) diameter.	1-4	5-24 PRICE EACH	25-UP
VI-V8901-TEN-B Standard PEN-VAC, static dissipative Buna-N cups	€ 70.00	-	-
VI-V8920E-TEN-B Junior PEN-VAC, static dissipative Buna-N cups	€ 70.00	-	-
			
PEN-VAC KIT WITH 6 PROBES + CUPS, PLASTIC CASE Two of each size cup on one bent and one straight probe. Cup sizes are 1/8" (3.18mm), 1/4" (6.35mm), 3/8" (9.53mm) diameter. Case has locations for each item.	1-4	5-24 PRICE EACH	25-UP
VI-V8901-D-B Standard PEN-VAC, static dissipative Buna-N cups	€ 70.00	-	-
VI-V8920E-D-B Junior PEN-VAC, static dissipative Buna-N cups	€ 70.00	-	-
			
PEN-VAC WITHOUT PROBES OR VACUUM CUPS You order the probes and cups that you need.	1-4	5-24 PRICE EACH	25-UP
V8901-X-ESD Standard PEN-VAC	€ 62.00	-	-
V8920E-X-ESD Junior PEN-VAC	€ 62.00	-	-
No Probes or Cups			

Prices subject to change without notice.

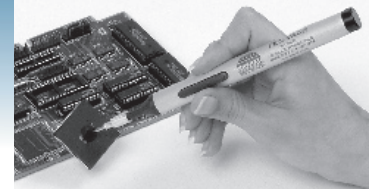

These ESD-safe units feature a silver aluminum body and non-marking static dissipative Buna-N black rubber vacuum cups. Vacuum is generated by pressing and releasing the vacuum push button.

STANDARD SIZE
5 3/4" (146mm) long
1/2" (12.7mm) diameter

Colors:
silver, red and blue





PRO-SERIES

PEN-VAC® VACUUM HANDLING TOOL KITS

LIGHT WEIGHT ESD-SAFE PLASTIC,
CONDUCTIVE SILICONE CUPS

These economically priced tools are available with a black or gray static dissipative plastic body and with conductive black silicone vacuum cups. Vacuum is generated by pressing and releasing the vacuum push button.

PRO-SERIES PEN-VAC

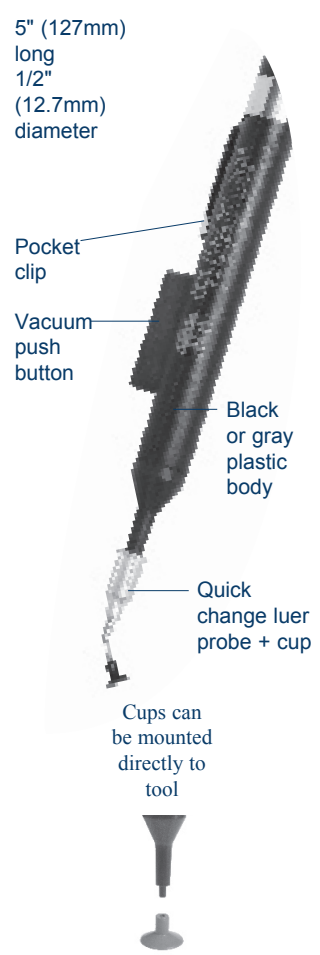

PRO-SERIES PEN-VAC KIT WITH 4 PROBES + CUPS		1-4	5-24	25-UP
Three bent probes with 1/8" (3.18mm), 1/4" (6.35mm), 3/8" (9.53mm), diameter vacuum cups, one straight probe with 1/4" (6.35mm) diameter vacuum cup.		PRICE EACH		
V8910-9BK-ESD	Black body, conductive silicone cups	€ 48.00	-	-
V8910-9GR-ESD	Gray body, conductive silicone cups	€ 48.00	-	-
PRO-SERIES PEN-VAC KIT WITH 6 PROBES + CUPS		1-4	5-24	25-UP
Two of each size cup on one bent and one straight probe. Cup sizes are 1/8" (3.18mm), 3/16" (4.76mm), 1/4" (6.35mm) diameter.		PRICE EACH		
V8910-BK-MPS-ESD	Black body, conductive silicone cups	€ 48.00	-	-
V8910-GR-MPS-ESD	Gray body, conductive silicone cups	€ 48.00	-	-
PRO-SERIES PEN-VAC KIT WITH 6 PROBES + CUPS		1-4	5-24	25-UP
Two of each size cup on one bent and one straight probe. Cup sizes are 1/8" (3.18mm), 1/4" (6.35mm), 3/8" (9.53mm) diameter.		PRICE EACH		
V8910-BK-LMS-ESD	Black body, conductive silicone cups	€ 48.00	-	-
V8910-GR-LMS-ESD	Gray body, conductive silicone cups	€ 48.00	-	-
PRO-SERIES PEN-VAC KIT WITH 6 PROBES + CUPS		1-4	5-24	25-UP
Two of each size cup on one bent and one straight probe. Cup sizes are 1/4" (6.35mm), 3/8" (9.53mm), 1/2" (12.7mm) diameter.		PRICE EACH		
V8910-BK-HLM-ESD	Black body, conductive silicone cups	€ 48.00	-	-
V8910-GR-HLM-ESD	Gray body, conductive silicone cups	€ 48.00	-	-
PRO-SERIES PEN-VAC KIT WITH 10 PROBES + CUPS		1-4	5-24	25-UP
Two of each size cup on one bent and one straight probe. Cup sizes are 1/8" (3.18mm), 3/16" (4.76mm), 1/4" (6.35mm), 3/8" (9.53mm), 1/2" (12.7mm) diameter.		PRICE EACH		
V8910-BK-TEN-ESD	Black body, conductive silicone cups	€ 48.00	-	-
V8910-GR-TEN-ESD	Gray body, conductive silicone cups	€ 48.00	-	-
PRO-SERIES PEN-VAC WITHOUT PROBES OR VACUUM CUPS		1-4	5-24	25-UP
You order the probes and cups that you need. See pages 11 and 12 for details.		PRICE EACH		
V8910-BK-X	Black body	€ 42.00	-	-
V8910-GR-X	Gray body	€ 42.00	-	-
No Probes or Cups				
PRO-SERIES DISPLAY PACK		1-4	5-24	25-UP
Two bent, two straight probes with 1/8" (3.18mm), 1/4" (6.35mm), 3/8" (9.53mm), 1/2" (12.7mm) diameter vacuum cups		PRICE EACH		
VPB8910-9BK-ESD	Black body, conductive silicone cups	€ 48.00	-	-
VPB8910-9GR-ESD	Gray body, conductive silicone cups	€ 48.00	-	-

Prices subject to change without notice.



VACULA® & SLIM-VAC®

ESD-SAFE VACUUM HANDLING TOOL KITS

SLIM BODY DESIGN

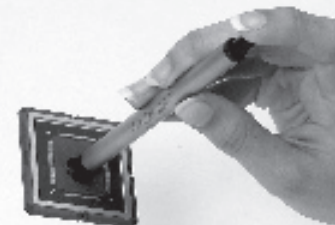

The top plunger actuated VACULA is suited for heavier items and perpendicular handling to the work surface.

Our SLIM-VAC line of tools functions like a PEN-VAC. The body of this tool is 3/8" (9.53mm) in diameter.

VACULA KIT WITH 3 PROBES + CUPS

Designed to handle parts when moving them into and out of burn-in trays, test sockets or other component transfer operations. The plunger in the rear of the tool activates the vacuum. The VACULA is ESD-safe and is available in two different models. The VC-1 comes with or without three vacuum cups on probes, 1/4" (6.35mm), 3/8" (9.53mm) and 1/2" (12.7mm) diameter.

		1-4	5-24 PRICE EACH	25-UP
VC-1-B	With Static dissipative Buna-N rubber cups	€ 89.90	83.60	77.80
VC-1-ESD	With Conductive silicone cups	€ 89.90	83.60	77.80
VC-1-X	Tool only, no cups or probes	€ 77.30	71.30	66.85



VACULA-2 KIT WITH 2 CUPS

Designed to handle parts when moving them into and out of burn-in trays, test sockets or other component transfer operations. The plunger in the rear of the tool activates the vacuum. The VACULA is ESD-safe and is available in two different models. The VC-2 is provided with or without two vacuum cups, 1/2" (12.7mm) and 5/8" (15.88mm) diameter, that slip onto a barbed fitting. The barbed fitting provides extra lifting power.

		1-4	5-24 PRICE EACH	25-UP
VC-2-B	With Static dissipative Buna-N rubber cups	€ 89.90	83.60	77.80
VC-2-ESD	With Conductive silicone cups	€ 89.90	83.60	77.80
VC-2-X	Tool only, no cups	€ 77.30	71.20	66.85



SLIM-VAC WITH 4 PROBES + CUPS

An ergonomically designed vacuum handling tool that fits the hand more like a small pen. A retractable eye in the rear of the stainless steel tool allows connection to a retaining cord. The SLIM-VAC kit is delivered to you with or without four vacuum cups and probes (one bent and one straight probe with 1/8" (3.18mm) diameter vacuum cups, one bent probe with 1/4" (6.35mm) diameter vacuum cup, and one straight probe with 3/8" (9.53mm) diameter vacuum cup).

		1-4	5-24 PRICE EACH	25-UP
V9501-B	With Static dissipative Buna-N rubber cups	€ 89.90	83.60	77.80
V9501-ESD	With Conductive silicone cups	€ 89.90	83.60	77.80
V9501-X	Tool only, no cups or probes	€ 77.30	71.20	66.85



SLIM-VAC WITH 6 PROBES + CUPS

Two of each size cup on one bent and one straight probe. Cup sizes are 1/8" (3.18mm), 1/4" (6.35mm), 3/8" (9.53mm) diameter.

		1-4	5-24 PRICE EACH	25-UP
V9501-LMS-B	With Static dissipative cups	€ 97.10	90.35	84.00
V9501-LMS-ESD	With Conductive silicone cups	€ 97.10	90.35	84.00



SLIM-VAC WITH 4 PROBES + CUPS

Three bent probes with 1/8" (3.18mm), 1/4" (6.35mm), 3/8" (9.53mm), diameter vacuum cups, one straight probe with 1/4" (6.35mm) diameter vacuum cup.

		1-4	5-24 PRICE EACH	25-UP
V9501-A-B	With Static dissipative Buna-N rubber cups	€ 89.90	83.60	77.80
V9501-A-ESD	With Conductive silicone cups	€ 89.90	83.60	77.80



VACULA
5 1/2" (139.7mm) long
3/8" (9.53mm) diameter



VACULA-2
5 1/4" (133.35mm) long
3/8" (9.53mm) diameter

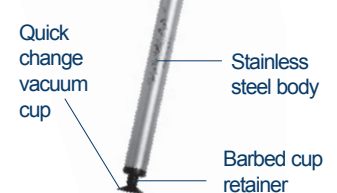

SLIM-VAC
4 5/8" (117.48mm) long
3/8" (9.53mm) diameter

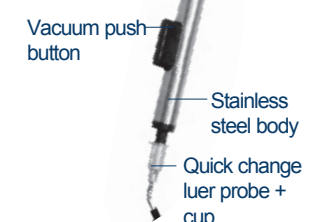

Prices subject to change without notice.

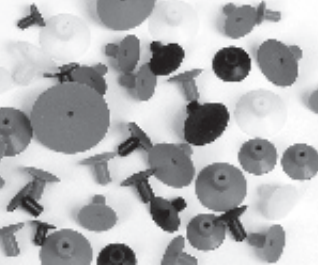

VACUUM CUPS

ESD-SAFE AND NON-ESD-SAFE

We offer a wide selection of vacuum cups to meet your handling needs. Our vacuum cups can handle electronic components, glass lenses, hot components in the soldering/ rework process, high- temperature and certain medical applications.

VACUUM CUPS	ESD-SAFE	1-49	50-99	100-UP
Please specify product by adding B or ESD to end of product number.		<i>PRICE EACH</i>		
* <i>B</i> to order the black Buna-N static dissipative non-marking material.				
* <i>ESD</i> to order the black high-temperature conductive silicone material.				
VI-V9009-*	3/32" (2.38mm) diameter vacuum cup	€ 1.98	1.91	1.85
VI-V9013-*	1/8" (3.18mm) diameter vacuum cup, longer stem	€ 1.98	1.91	1.85
VI-V9018-*	3/16" (4.76mm) diameter vacuum cup	€ 1.98	1.91	1.85
VI-V9025-*	1/4" (6.35mm) diameter vacuum cup	€ 1.98	1.91	1.85
VI-V9038-*	3/8" (9.53mm) diameter vacuum cup	€ 1.98	1.91	1.85
VI-V9050-*	1/2" (12.70mm) diameter vacuum cup	€ 1.98	1.91	1.85
VI-V9062-*	5/8" (15.88mm) diameter vacuum cup	€ 3.05	2.91	2.78
VI-V9075-*	3/4" (19.05mm) diameter vacuum cup	€ 3.05	2.91	2.78
VI-V9000K8-*	Kit of one each of the above vacuum cups (8)	€ 17.95	17.18	16.47

Example: VI-V9009-ESD is the 3/32" (2.38mm) diameter vacuum cup in the conductive silicone material.

VACUUM CUPS	NON-ESD-SAFE	1-49	50-99	100-UP
Please specify product by adding W, R, U or C to end of product number.		<i>PRICE EACH</i>		
* <i>W</i> to order the white silicone material.				
* <i>R</i> to order the high-temperature red silicone material.				
* <i>U</i> to order the high-temperature blue silicone material.				
* <i>C</i> to order the high-temperature clear silicone material.				
VI-V9009-*	3/32" (2.38mm) diameter vacuum cup	€ 1.98	1.91	1.85
VI-V9013-*	1/8" (3.18mm) diameter vacuum cup, longer stem	€ 1.98	1.91	1.85
VI-V9018-*	3/16" (4.76mm) diameter vacuum cup	€ 1.98	1.91	1.85
VI-V9025-*	1/4" (6.35mm) diameter vacuum cup	€ 1.98	1.91	1.85
VI-V9038-*	3/8" (9.53mm) diameter vacuum cup	€ 1.98	1.91	1.85
VI-V9050-*	1/2" (12.70mm) diameter vacuum cup	€ 1.98	1.91	1.85
VI-V9062-*	5/8" (15.88mm) diameter vacuum cup	€ 3.05	2.91	2.78
VI-V9075-*	3/4" (19.05mm) diameter vacuum cup	€ 3.05	2.91	2.78
VI-V9000K8-*	Kit of one each of the above vacuum cups (8)	€ 17.95	17.18	16.47

Example: VI-V9009-R is the 3/32" (2.38mm) diameter vacuum cup in the high-temperature red silicone material.

Prices subject to change without notice.

DIMENSIONS IN INCHES (MILLIMETERS)

PART #	SIZE	A	B	C	OD	ID	PS	E
VI-V9009-*	3/32	0.094(2.39)	0.140(3.56)	0.160(4.06)	0.078(1.98)	0.040(1.02)	0.045(1.14)	0.020(0.51)
VI-V9013-*	1/8	0.125(3.18)	0.160(4.06)	0.180(4.57)	0.100(2.54)	0.060(1.52)	0.055(1.40)	0.035(0.89)
VI-V9018-*	3/16	0.188(4.76)	0.175(4.45)	0.200(5.08)	0.130(3.30)	0.060(1.52)	0.055(1.40)	0.035(0.89)
VI-V9025-*	1/4	0.250(6.35)	0.160(4.06)	0.200(5.08)	0.100(2.54)	0.060(1.52)	0.055(1.40)	0.035(0.89)
VI-V9038-*	3/8	0.375(9.53)	0.190(4.83)	0.250(6.35)	0.125(3.18)	0.060(1.52)	0.055(1.40)	0.035(0.89)
VI-V9050-*	1/2	0.500(12.70)	0.190(4.83)	0.300(7.62)	0.160(4.06)	0.060(1.52)	0.055(1.40)	0.035(0.89)
VI-V9062-*	5/8	0.625(15.88)	0.175(4.45)	0.315(8.00)	0.160(4.06)	0.060(1.52)	0.055(1.40)	0.035(0.89)
VI-V9075-*	3/4	0.750(19.05)	0.140(3.56)	0.320(8.13)	0.160(4.06)	0.060(1.52)	0.055(1.40)	0.035(0.89)

**B* to order the black Buna-N static dissipative non-marking material. (-5°F + 250°F) (-20°C + 120°C)

**ESD* to order the black high-temperature conductive silicone material. (-65°F + 445°F) (-55°C + 230°C)

**R* to order the high-temperature red silicone material. (-65°F + 480°F) (-55°C + 250°C)

**U* to order the high-temperature blue silicone material. (-65°F + 480°F) (-55°C + 250°C)

**C* to order the high-temperature clear silicone material. (-65°F + 480°F) (-55°C + 250°C)

**W* to order the white silicone material. (-65°F + 480°F) (-55°C + 250°C)

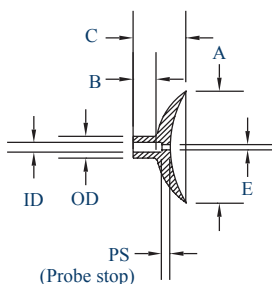

VACUUM PROBES & CUPS

ESD-SAFE AND NON-ESD-SAFE

METAL PROBES WITH ESD-SAFE VACUUM CUPS

Please specify product by adding straight or bent probe (S or B) to end of each product number.

**S to order a straight probe. **B to order a bent probe.

VI-V8903-†-**	Black Buna-N static dissipative non-marking cup with 1/2" (12.7mm) probe
VI-V8913-†-**	Black Buna-N static dissipative non-marking cup with 1" (25.4mm) probe
VI-V8904-†-**	High-temperature black conductive silicone cup with 1/2" (12.7mm) probe
VI-V8914-†-**	High-temperature black conductive silicone cup with 1" (25.4mm) probe

	1-49	50-99 PRICE EACH	100-UP
†-D to order with the 3/32" (2.38mm) vacuum cup	€ 3.85	3.72	3.60
†-S to order with the 1/8" (3.18mm) vacuum cup	€ 3.85	3.72	3.60
†-P to order with the 3/16" (4.76mm) vacuum cup	€ 3.85	3.72	3.60
†-M to order with the 1/4" (6.35mm) vacuum cup	€ 3.85	3.72	3.60
†-L to order with the 3/8" (9.53mm) vacuum cup	€ 3.85	3.72	3.60
†-H to order with the 1/2" (12.7mm) vacuum cup	€ 3.85	3.72	3.60
†-J to order with the 5/8" (15.88mm) vacuum cup	€ 4.95	4.74	4.55
†-K to order with the 3/4" (19.05mm) vacuum cup	€ 4.95	4.74	4.55

Example: V8903-M-B is a bent 1/2" (12.7mm) probe with the 1/4" (6.35mm) Black Buna-N static dissipative non-marking cup.

METAL PROBES WITH NON-ESD-SAFE VACUUM CUPS

Please specify product by adding straight or bent probe (S or B) to end of each product number.

**S to order a straight probe. **B to order a bent probe.

VI-V8902-†-**	High-temperature red silicone cup with 1/2" (12.7mm) probe
VI-V8912-†-**	High-temperature red silicone cup with 1" (25.4mm) probe
VI-V8906-†-**	High-temperature blue silicone cup with 1/2" (12.7mm) probe
VI-V8916-†-**	High-temperature blue silicone cup with 1" (25.4mm) probe
VI-V8907-†-**	High-temperature clear silicone cup with 1/2" (12.7mm) probe
VI-V8917-†-**	High-temperature clear silicone cup with 1" (25.4mm) probe

	1-49	50-99 PRICE EACH	100-UP
†-D to order with the 3/32" (2.38mm) vacuum cup	€ 3.85	3.72	3.60
†-S to order with the 1/8" (3.18mm) vacuum cup	€ 3.85	3.72	3.60
†-P to order with the 3/16" (4.76mm) vacuum cup	€ 3.85	3.72	3.60
†-M to order with the 1/4" (6.35mm) vacuum cup	€ 3.85	3.72	3.60
†-L to order with the 3/8" (9.53mm) vacuum cup	€ 3.85	3.72	3.60
†-H to order with the 1/2" (12.7mm) vacuum cup	€ 3.85	3.72	3.60
†-J to order with the 5/8" (15.88mm) vacuum cup	€ 4.95	4.74	4.55
†-K to order with the 3/4" (19.05mm) vacuum cup	€ 4.95	4.74	4.55

Example: VI-V8902-M-B is a bent 1/2" (12.7mm) probe with the 1/4" (6.35mm) high-temperature red silicone vacuum cup.

METAL PROBES NO CUPS

The precision metal probes have a metal hub that fits any of our vacuum handling tools. Custom bends and lengths are available upon request.

	1-49	50-99 PRICE EACH	100-UP	
VI-V3950-B	18 ga. bent 1/2" (12.7mm) probe	€ 1.98	1.91	1.85
VI-V3950-S	18 ga. straight 1/2" (12.7mm) probe	€ 1.98	1.91	1.85
VI-V3950-B-1	18 ga. bent 1" (25.4mm) probe	€ 2.10	2.02	1.95
VI-V3950-S-1	18 ga. straight 1" (25.4mm) probe	€ 2.10	2.02	1.95
VI-V3972-B	15 ga. bent 1/2" (12.7mm) probe	€ 1.98	1.91	1.85
VI-V3972-S	15 ga. straight 1/2" (12.7mm) probe	€ 1.98	1.91	1.85
VI-V3972-B-1	15 ga. bent 1" (25.4mm) probe	€ 2.10	2.02	1.95
VI-V3972-S-1	15 ga. straight 1" (25.4mm) probe	€ 2.10	2.02	1.95



Vacuum probes are available with or without attached vacuum cups, which will fit most of your handling applications. The luer slip connector fits all of our vacuum handling tools. Custom probe lengths and bends are available upon request.

STRAIGHT PROBES & CUPS



BENT PROBES & CUPS



BENT & STRAIGHT PROBES



CONTINUOUS POWERED VACUUM HANDLING TOOLS

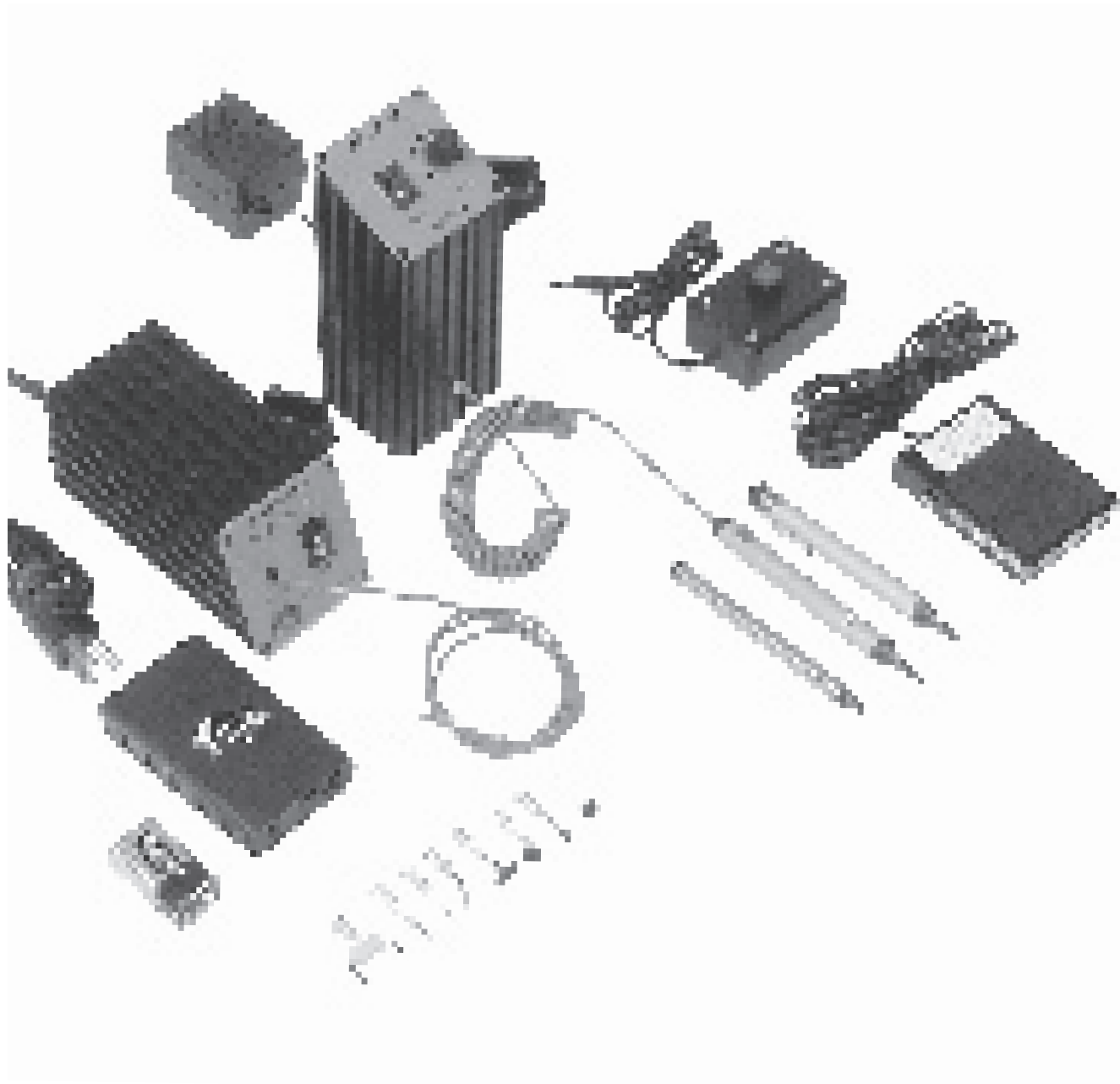

SMD-VAC™ SERIES

ESD-SAFE VACUUM HANDLING SYSTEMS

SMD-VAC™-GP

A general purpose vacuum handling tool that plugs directly into 110 VAC or 220 VAC 50-60 HZ. This compact unit will handle most of the surface mount components used in industry today. The long life diaphragm vacuum pump generates six inches of mercury. The unit connects to ground automatically with a three wire power cord.

The SMD-VAC-GP comes complete with the following features:

- Whisper-quiet operation.
- 4 feet of straight vacuum hose, #VSH-1/16-4.
- 4 feet of coiled vacuum hose, #VCH-1/16-4.
- A set of seven vacuum tips, #VCS-7-B.
- A vacuum pick-up handle, #V3020-RF-1/16.
- Rubber no-skid feet.
- Produces vacuum of over six inches of mercury.
- Optional side mounted handle holder.

		1-9	10-24	25-UP
		PRICE EACH		
V8000	For 110 VAC	not available in the EU		
V8000-220	For 220 VAC	€ 225.00	213.80	202.50
V8000-X	No tips, handles or hoses, for 110 VAC	not available in the EU		
VCS-7-B	Replacement probe/cup kit	€ 25.70	24.40	23.10

WITH OPTIONAL SIDE MOUNTED VACUUM PEN HOLDER

		1-9	10-24	25-UP
		PRICE EACH		
V8000-HLD	For 110 VAC	not available in the EU		
V8000-220-HLD	For 220 VAC	€ 252.00	240.00	227.00

SMD-VAC™-HP

Additional pick-up power for handling small to very large size components. The precision pump and motor generate over fifteen inches of mercury. The compact tower design takes up a very small footprint on the bench. An electric eye pen holder on the side automatically shuts the unit off when the vacuum pen is placed in it. A jack on the rear of the V8100A series allows use of the optional foot or hand switch to control vacuum during pick and place operations. The SMD-VAC-HP comes complete with the following features:

- Quiet operation.
- 4 feet of straight vacuum hose, #VSH-1/16-4.
- 4 feet of coiled vacuum hose, #VCH-1/16-4.
- A set of seven vacuum tips, #VCS-7-B.
- A vacuum pick-up handle, #V3020-RF-1/16.
- 12 volt power source.
- Automatic vacuum pump ON/OFF control.
- Rubber no-skid feet.
- ESD connection on rear of unit.
- Produces vacuum of over fifteen inches of mercury.
- Foot or hand switch is optional.

		1-9	10-24	25-UP
		PRICE EACH		
V8100A	For 110 VAC	not available in the EU		
V8100A-FS	With foot switch, for 110 VAC	not available in the EU		
V8100A-HS	With hand switch, for 110 VAC	not available in the EU		
V8100A-220	For 220 VAC	€ 621.00	589.95	559.00
V8100A-220-FS	With foot switch, for 220 VAC	€ 684.00	650.00	616.00
V8100A-220-HS	With hand switch, for 220 VAC	€ 684.00	650.00	616.00
V8100	No solenoid or foot/hand switch connection, for 110 VAC	not available in the EU		
V8100-220	No solenoid or foot/hand switch connection, for 220 VAC	€ 522.00	495.50	470.00
VCS-7-B	Replacement probe/cup kit	€ 26.55	24.40	23.10

FOOT OR HAND SWITCH WITH VACUUM PEN

Can be used with SMD-VAC-HP tools that have the optional foot switch jack at rear of unit. (This will include handle V3021).

		1-9	10-24	25-UP
		PRICE EACH		
VFS-1	Foot switch	€ 81.00	77.00	73.00
VHS-1	Hand switch (not shown)	€ 81.00	77.00	73.00v

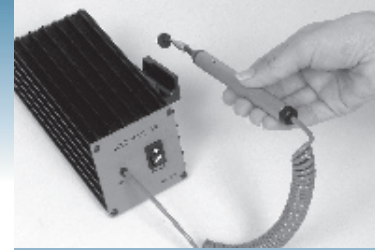

The SMD-VAC series of bench top vacuum handling systems offer quiet operation and ESD safe protection.

SMD-VAC-GP
3" X 6" X 2 1/2"
(76mm X 152mm X 64mm)

Black
Aluminum
Case



SMD-VAC-HP
3" X 2 1/2" X 6"
(76mm X 64mm X 152mm)

Variable
Air Flow
Control

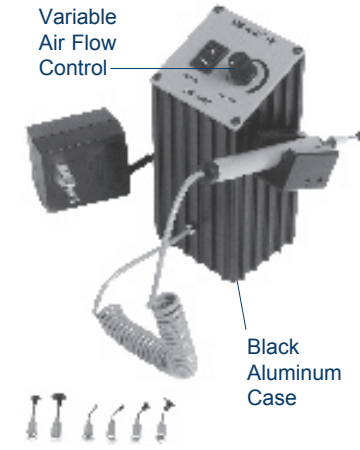

Black
Aluminum
Case

OPTIONAL FOOT SWITCH



Prices subject to change without notice.

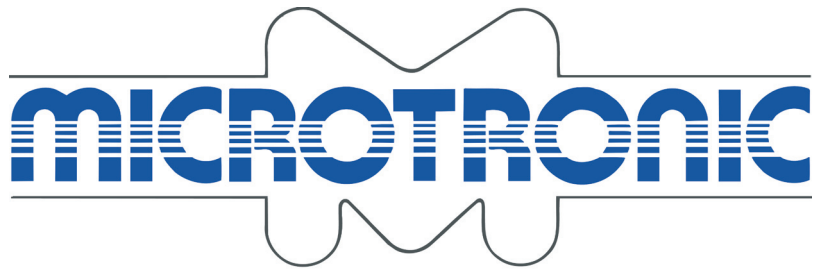

MICROTRONIC MICROELECTRONIC VERTRIEBS GMBH

Microtronic Microelectronic Vertriebs GmbH
Klein Grötzing
D-84494 Neumarkt-Sankt Veit

Tel: 08422/9620-0 Fax: -30
Email: info@microtronic.de
Web: www.microtronic.de

Überreicht durch:



2130 Victor Place • Colorado Springs, Colorado 80915 • 719-572-5566 800-530-8377 Fax 719-572-5504
www.virtual-ii.com e-mail: info@virtual-ii.com